

*Ammunition inspection for precision.*

# InSpec

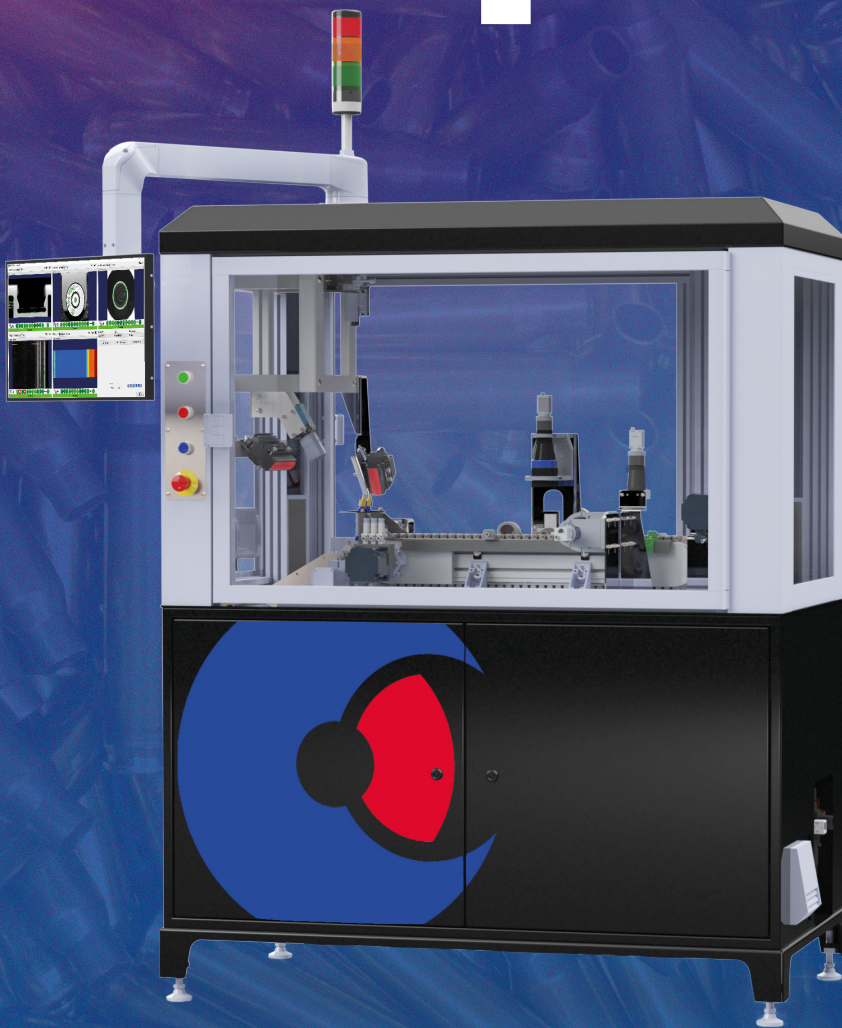

 **mabema**





Our history began in the Swedish nuclear power industry in the early 2000s where we learnt to deliver high-quality vision system to customers with high demands. We analyze more than 120 billion images every year in the most demanding manufacturing industries such as medicine and automotive.

We have broad and high-level R&D expertise in advanced camera technology and image processing that enables innovative, easy-to-use and state-of-the-art machine vision solutions.

At Mabema, we are passionate about what we do. We are at the forefront of the development of machine vision technology in Europe and it is our passion that drives us to do better every day. We offer high competence support and service to our customers to ensure that our products always operate at the highest level possible.



# InSpec

InSpec is carefully developed to ensure **high quality ammunition production**. Through single source laser triangulation, we can guarantee accurate inspection, free from multiple sources of miscalculations.

It objectively **detects, identifies and quantifies** critical defects. With the throughput of 120 parts per minute the machine can thoroughly detect 30+ defects, faster and more accurate than the human eye. Rejected parts are **sorted into four different reject bins** depending on the defect, enabling fast subjective inspection.

A few examples of the defects our machines detect are **bulges, scratches, dents, neck folds, concentricity** and more. With real time statistics, you can quickly locate where in the manufacturing process maintenance actions are needed to **minimize rejected cases or cartridges**.

The changeover between calibers is straightforward, takes less than three minutes and **does not require tools** nor camera and light source adjustments. Our InSpec machine comes in **two different models** depending on caliber size: standard and large. No matter the model we keep the machines at the **small footprint** of 770 x 1 450 x 2 350 mm / 30 x 57 x 92.5 " by using the same cabinet.

Model	Diameter of caliber	Length of caliber
InSpec Standard	6 – 16 mm / 0.23 – 0.63 "	15 – 100 mm / 0.6 – 3.9 "
InSpec Large	14 – 25 mm / 0.55 – 0.98 "	70 – 140 mm / 2.7 – 5.5 "

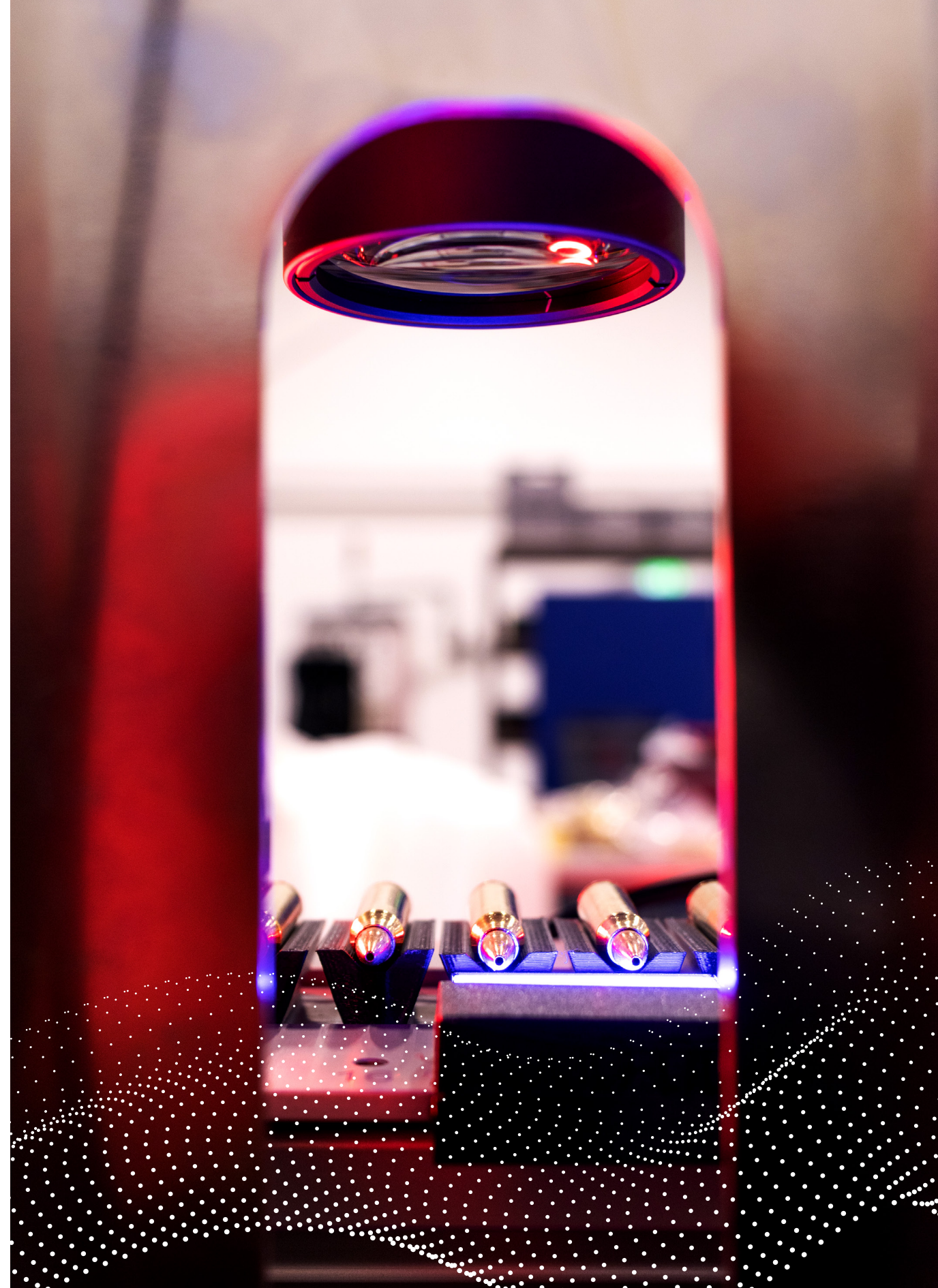





## Rejection sorting

Instead of sorting all defects in one single bin, InSpec **sorts defects per defect category**. This provides a quick visual overview of the quality status of the current batch.

## Footprint

InSpec has a **small footprint** of 770 x 1 450 x 2 350 mm / 30 x 57 x 92.5 " which makes it one of the smallest ammunition inspection machines on the market.

## Caliber changeover

When needed, a caliber changeover is done in **less than three minutes** with no adjustments of cameras nor light sources.

## Controlled feeding

The parts are **transported in fixed positions** on a conveyor belt operated by servo, independent of friction and gravity.



# Full body inspection



## Extractor Groove

- Missing extractor groove/extractor defects
- Magnum belt
- Groove depth
- Extractor thickness and angle
- Rim thickness
- Rim diameter
- Extractor diameter



## Head

- Head stamp
- Primer presence, dents and scratches
- Colored sealant coating (paint if applicable)
- Crimp (if applicable)
- Flash hole presence, diameter and placement
- Chips or dirt in flash hole

8

## Case

- Bulges
- Cracks
- Dents
- Scratches
- Folds
- Total length
- Annealing
- Concentricity
- Surface stains

## Projectile

- Bullet tip shape
- Wrong bullet type
- Larger tip defects
- Color of paint
- Scratches

## Mouth

- Missing material
- Cracks
- Circularity
- Chips
- Notches
- Burr
- Mouth folds



9



# Inspection examples

InSpec offers unparalleled defect detection capabilities, capable of identifying 30+ defects. One of the key features of InSpec is its intelligent sorting system, which categorizes defects based on their location on the part's body. This enables an efficient defect sorting process, while also ensuring that defective parts are separated and handled appropriately.



1. Mouth split

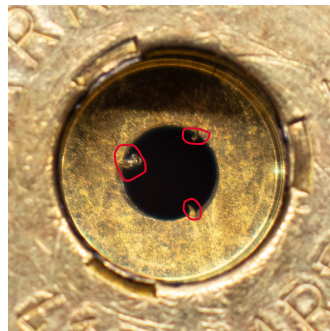

2. Chip in fire hole



3. Chip in mouth



4. Scratch on neck



5. Neck fold

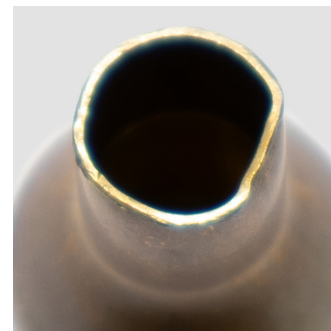

6. Bent mouth

Some defects that the machine detects can be difficult to recognize with the human eye, such as scratches or splits. The images above serves as references for defects that InSpec easily detects.

# Unique 360° 3D inspection

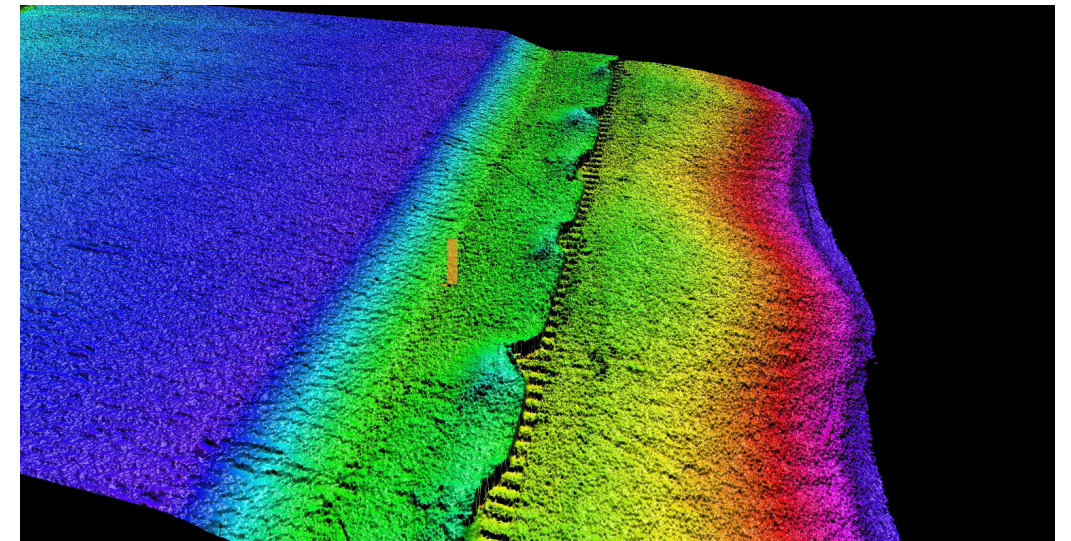

During rotation several images are acquired and stitched together to a full 360° 3D image of the unwrapped surface.

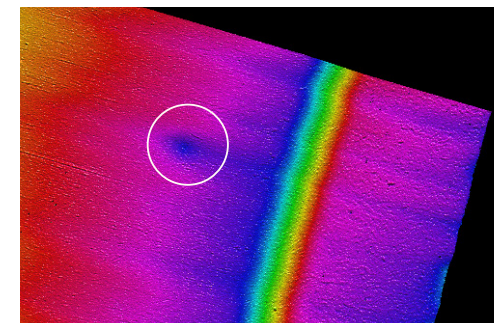

Above is a dent at the body detected with 3D technology. 3D data enables detection of geometrical defects at high resolution.



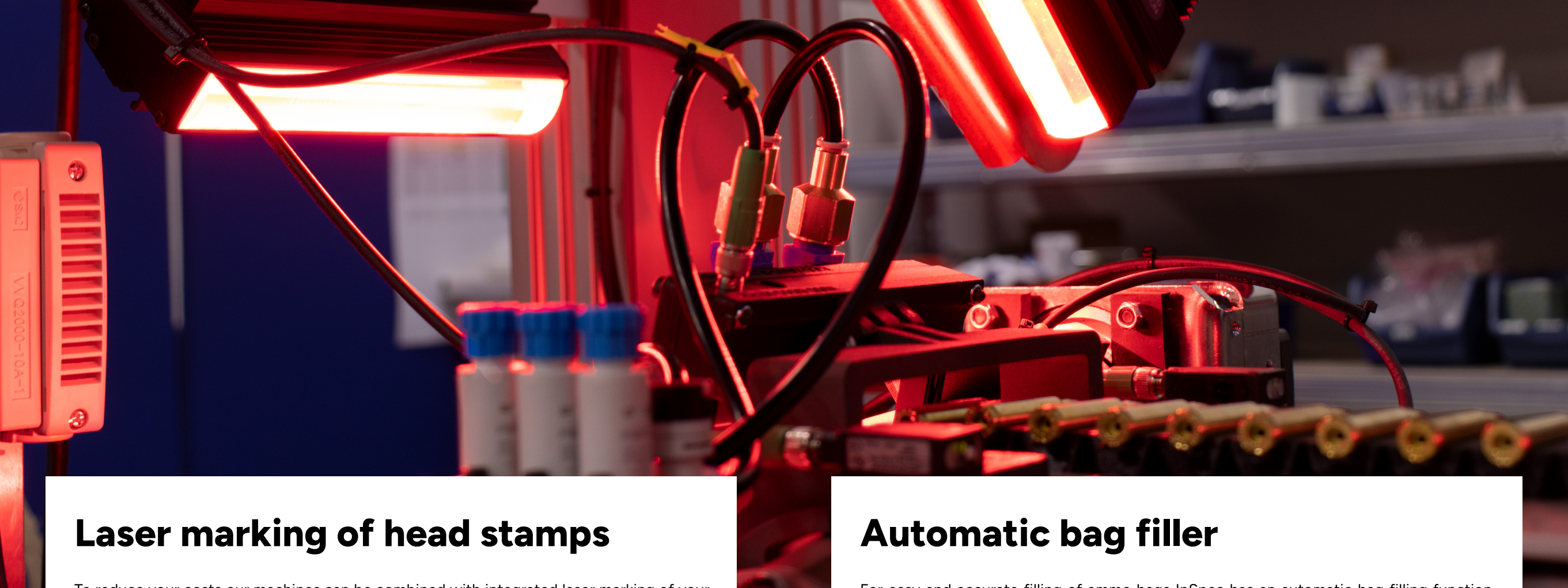

## Laser marking of head stamps

To reduce your costs our machines can be combined with integrated laser marking of your or your customers' head stamps. Unlimited number of headstamps can be stored in the software library.

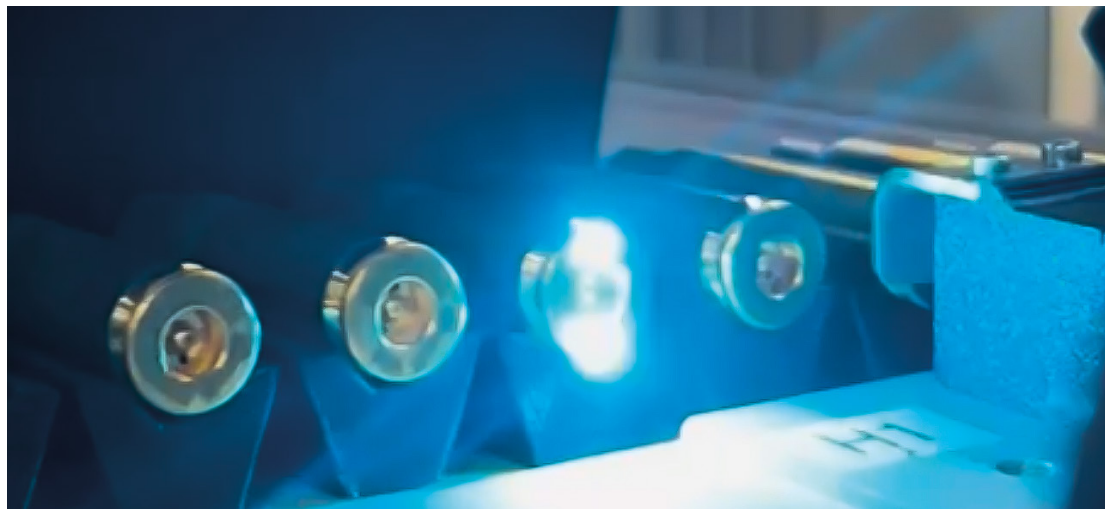

## Automatic bag filler

For easy and accurate filling of ammo bags InSpec has an automatic bag filling function. When one bag is full, the machine automatically switches to the next bag. The number of parts in a full bag can be customized to your needs.

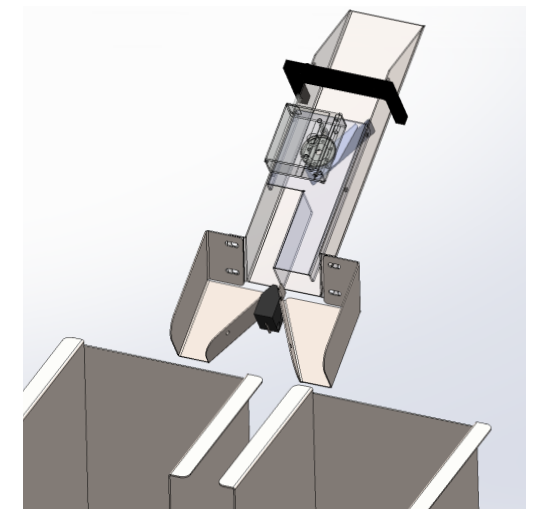



# MultiFeeder

Our MultiFeeder serves as a valuable add on to our InSpec machine both if you run multiple calibers or as a stand-alone unit to feed other machines in your production. It is caliber independent, and a caliber changeover is done in just a few minutes. In comparison to a typical bowl feeder our MultiFeeder is quieter and more gentle to your components and products.



## Benefits compared to a typical bowl feeder

Quieter

More gentle

Multiple caliber sizes

Fast caliber changeover

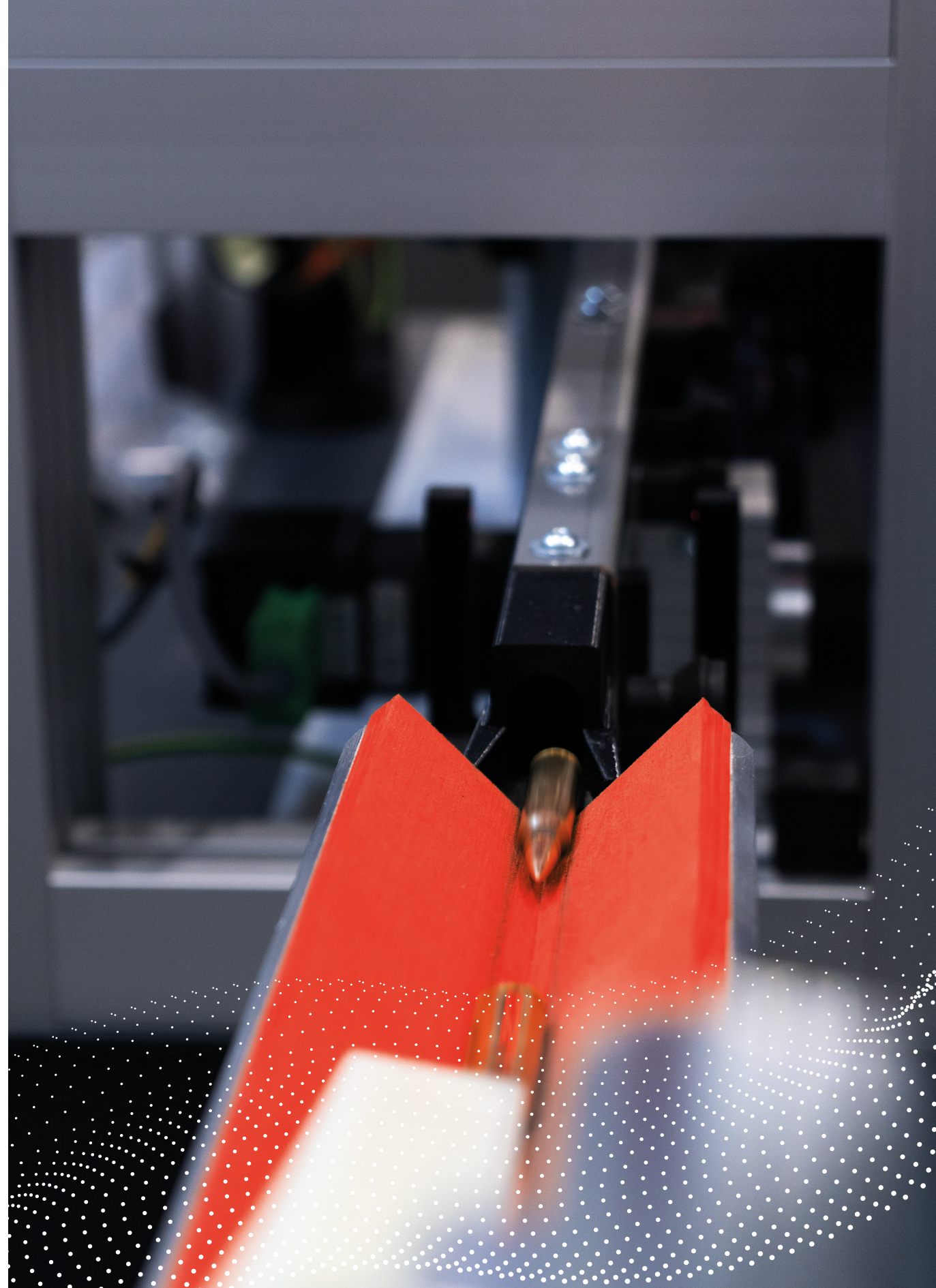





** mabema**

Mabema AB

[info@mabema.se](mailto:info@mabema.se) | +4673-515 37 45

[www.mabema.com](http://www.mabema.com)